

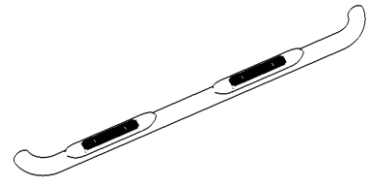

4" Oval Nerf Bar

Part No. A1009S/B



Fits: **2016-Current Toyota Tacoma Crew Cab**



REMOVE CONTENTS FROM BOX. VERIFY ALL PARTS ARE PRESENT.



READ INSTRUCTIONS CAREFULLY BEFORE STARTING INSTALLATION.

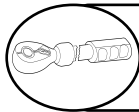

DO NOT OVER TORQUE. STANDARD OPERATING LOAD FOR TIGHTEN BODY MOUNT NUTS & BOLTS VARIES FROM **45 TO 65 FOOT POUND.**



60-180 min

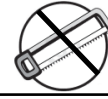

Cutting is not Required



Drilling is not Required



support@trailfx.com



1 866 638 4870



POLISHED STAINLESS STEEL - LIMITED LIFETIME
POWDER COATED BLACK - 3 YEARS

PARTS LIST:

Qty	Part Description	Qty	Part Description
1	Driver Sidebar	1	Driver/Left Rear Mounting Bracket
1	Passenger Sidebar	1	Passenger/Right Rear Mounting Bracket
1	Driver/Left Front Mounting Bracket	24	8-1.25mm x 30mm Hex Bolts
1	Passenger/Right Front Mounting Bracket	24	8mm Lock Washers
1	Driver/Left Middle Mounting Bracket	24	8mm ID x 24mm OD x 2mm Flat Washers
1	Passenger/Right Middle Mounting Bracket		

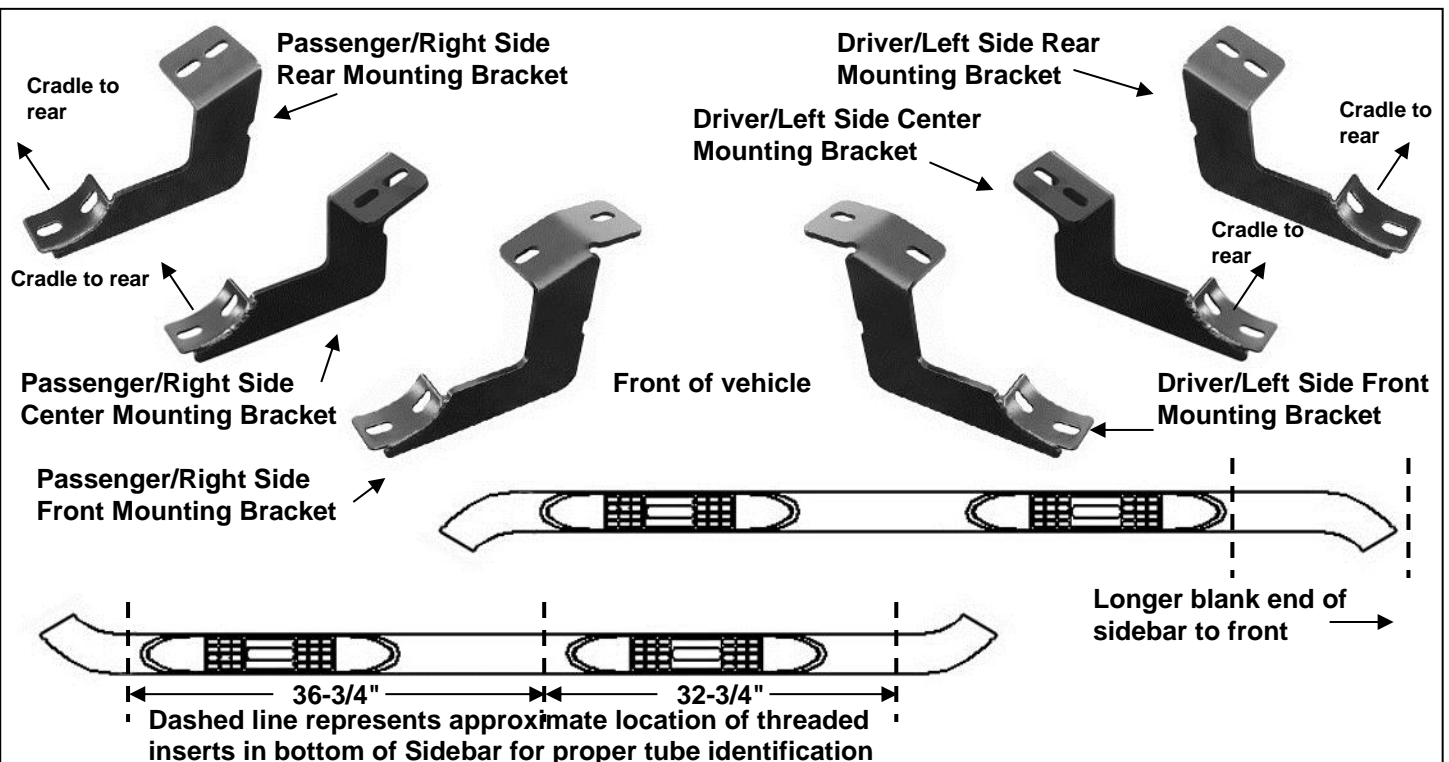

INSTALLATION PROCEDURE:

1. **USE ILLUSTRATION TO PROPERLY IDENTIFY BRACKETS AND SIDEBARS.**
2. Starting on the driver side front of the vehicle, use a flat screw driver to remove the plastic plugs covering the threaded holes in the body panel, (**Figure 1**). Select the driver side front Mounting Bracket and bolt it to the vehicle using the included (2) 8mm Hex Bolts, (2) 8mm Lock Washers and (2) 8mm Flat Washers, (**Figure 2**). Do not tighten hardware at this time.
3. Repeat Step 2 for center and rear Mounting Bracket installation, (**Figures 3 & 4**).
4. **IMPORTANT:** Use the illustration on this page to identify the Sidebars before continuing with the installation. Verify that the Brackets are in the correct locations as illustrated above. Carefully place the driver Sidebar onto the Brackets. Align the inserts in the bottom of the Sidebar with the slots on the Mounting Brackets. Attach the Sidebar to the Mounting Brackets with the included (6) 8mm Hex Bolts, (6) 8mm Lock Washers and (6) 8mm Flat Washers, (**Figure 4**). Do not tighten hardware at this time.
5. Level and adjust the Sidebar properly and tighten all hardware.
6. Repeat Steps 2 - 5 for passenger Sidebar installation.
7. Do periodic inspections to the installation to make sure that all hardware is secure and tight.

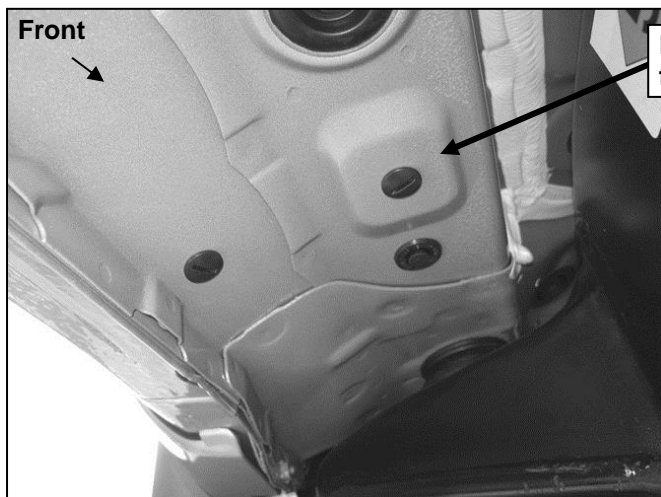
Driver Side Installation Pictured**(Fig 1) Driver side front mounting location pictured**

(2) 8mm x 30mm Hex Bolts
 (2) 8mm Flat Washers
 (2) 8mm Lock Washers

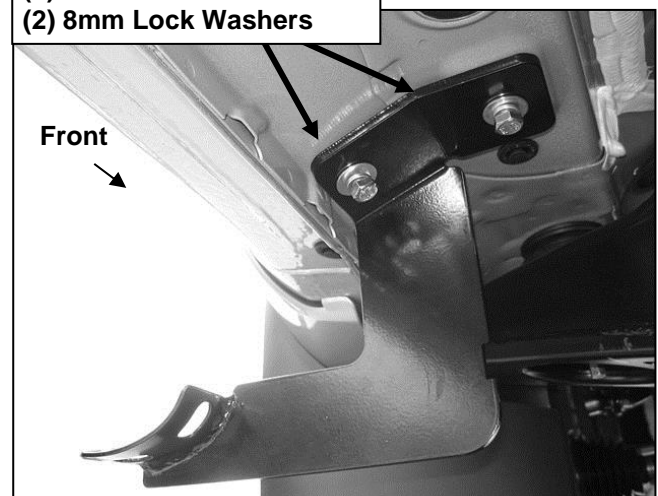
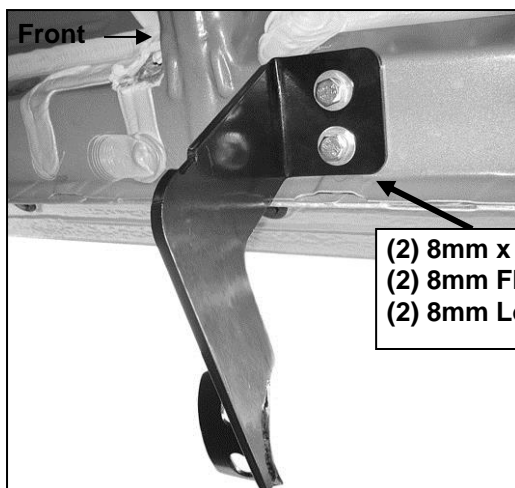
**(Fig 2) Driver side front mounting location pictured****(Fig 3) Driver side center mounting location pictured**

(2) 8mm x 30mm Hex Bolts
 (2) 8mm Flat Washers
 (2) 8mm Lock Washers

Driver Side Installation Pictured

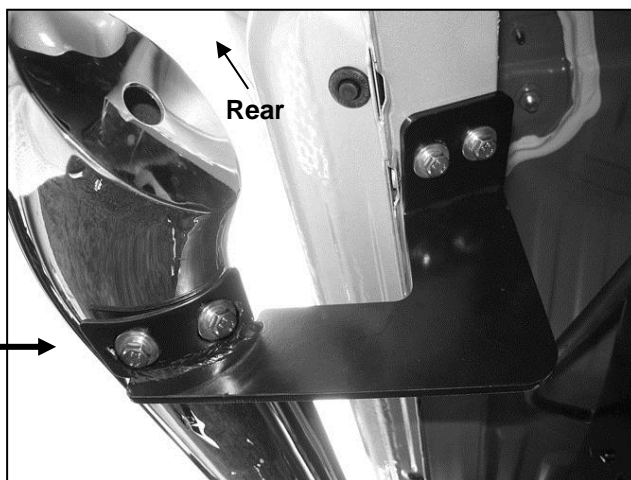

- (2) 8mm x 30mm Hex Bolts
- (2) 8mm Flat Washers
- (2) 8mm Lock Washers

(Fig 4) Driver side rear mounting location pictured



Complete Installation

PARTS IDENTIFICATION GUIDE

Driver Side tube packed using "Green" color foam sheet. Passenger Side tube packed using "White" color foam sheet

No.	Parts Identification
1	Passenger / Right 'Rear' Bracket marked "PR"
2	Driver / Left 'Rear' Bracket marked "DR"
3	Passenger / Right 'Center' Bracket marked "PC"
4	Driver / Left 'Center' Bracket marked "DC"
5	Passenger / Right 'Front' Bracket marked "PF"
6	Driver / Left 'Front' Bracket marked "DF"

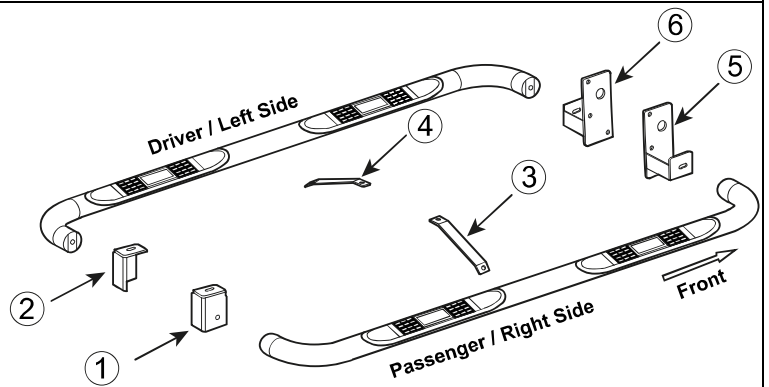
**Note:**

- This guide is to identify the parts and not a reference for part count.
- For part count, refer Parts List.
- Product / Bracket image is representative and actual design may vary.

PRODUCT CARE

- Periodically check the product to ensure all fasteners are tight and components are intact.
- Regular waxing is recommended to protect the finish of the product.
- **Use ONLY Non-Abrasive automotive wax.** Use of any soap, polish or wax that contains an abrasive is detrimental and can scratch the finish leading to corrosion.
- Aluminum polish may be used to polish small scratches and scuffs for **Stainless Steel finish.**
- Mild soap may be used to clean the product for both **Stainless Steel and Black finish.**

FAQ's**1. Hardware's are not of correct size.**

In GMC / Chevrolet truck model 2006 & up, customer needs to reuse the factory body bolts to install the bracket. If your vehicle is not GMC / Chevrolet 2006 & up, ensure that holes are not partially covered with any plastic grommet or rust? If it is, remove the plastic grommet & rust from the thread holes & re-try the installation.

2. Mounting Bracket are not getting Installed properly.

In some cases Illustration images shown in Installation manual may not be the exactly same as per actual vehicle images ,also if Driver / Passenger side mounting brackets are very identical in the design, suggest referring Parts Identification guide to avoid fitment issue.

3. Products are thumping / rattling after installation.

Ensure that all required mounting brackets / hardware's are installed & tighten correctly. Suggest using white lithium / regular grease between the metal to metal contact surfaces.

4. Side Bar is not aligning with vehicle / Step Pads are not aligning with vehicle doors.

Side bar may be interchanged or mounting brackets are not installed at the correct position in the vehicle. Refer Parts identification guide.

5. Missing / Excess Hardware.

Recheck hardware count as per the part list.

6. Product not installing properly.

Ensure make model year, cab length and bed size of your vehicle is listed in the application. All installation steps are followed correctly.

Check out these other TrailFX Products!!

www.TrailFX.com

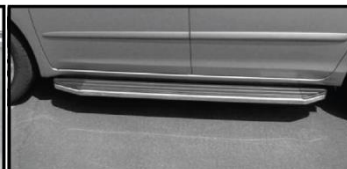
**GRILLE GUARDS****BED RAILS****RUNNING BOARDS****BULL BAR**

Keystone Automotive Operations Inc. (KAO) warrants this product to be free of defects in material and workmanship at the time of purchase by the original retail consumer. KAO disclaims any other warranties, express or implied, including the warranty of fitness for a particular purpose or an intended use. If the product is found to be defective, KAO may replace or repair the product at our option, when the product is returned prepaid, with proof of purchase. Alteration to, improper installation, or misuse of this product voids the warranty. KAO's liability is limited to repair or replacement of products found to be defective, and specifically excludes liability for any incidental or consequential loss or damage.